

E4	Pełny zbiornik wody	Jeżeli zbiornik wody jest pełny, znak ostrzegawczy "E4" pojawia się na wyświetlaczu. Aby ponownie uruchomić klimatyzator, należy wyjąć wtyczkę z gniazdka. Proszę użyć odpowiedniego pojemnika zbiorczego. Kiedy woda zostanie całkowicie usunięta, należy włączyć urządzenie ponownie. Urządzenie może być teraz używane jak zwykle. Procedura ta jest całkowicie normalna i zabezpiecza system przed oblodzeniem i uszkodzeniem. Urządzenie uruchamia się automatycznie po ok. 15 minut, jeszcze raz (w zależności od ustawienia funkcji). Procedura ta powtarza się regularnie.
DF	Funkcja przeciwzamrożeniowa	Procedura ta jest całkowicie normalna i zabezpiecza system przed oblodzeniem i uszkodzeniem. Urządzenie uruchamia się automatycznie po ok. 15 minut, jeszcze raz (w zależności od ustawienia funkcji). Procedura ta powtarza się regularnie.

To urządzenie jest oznaczone zgodnie z Dyrektywą Europejską 2002/96/WE oraz polską Ustawą o zużytych sprzęcie elektrycznym i elektronicznym symbolem przekreślonego kontenera na odpady.

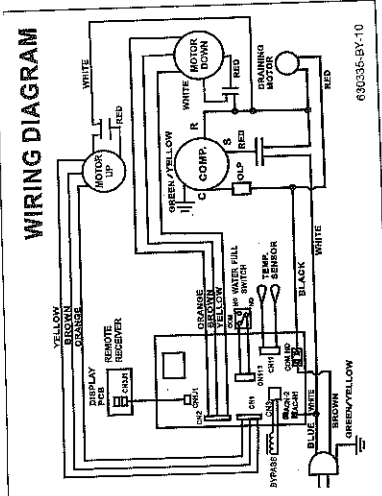

Takie oznakowanie informuje, że sprzęt ten, po okresie jego użytkowania nie może być umieszczany łącznie z innymi odpadami pochodzącymi z gospodarstwa domowego. Użytkownik jest zobowiązany do oddania go prowadzącym zbieranie zużytego sprzętu elektrycznego i elektronicznego. Prowadzący zbieranie, w tym lokalne punkty zbiórki, sklepy oraz gminne jednostki, tworzą odpowiedni system umożliwiający oddanie tego sprzętu. Właściwe postępowanie ze zużytym sprzętem elektrycznym i elektronicznym przyczynia się do uniknięcia szkód dla zdrowia ludzi i środowiska naturalnego konsekwencji, wynikających z obecności składników niebezpiecznych oraz niewłaściwego składowania i przetwarzania takiego sprzętu. W urzędzeniu ograniczono niektóre substancje mogące negatywnie oddziaływać na środowisko w okresie użytkowania tego produktu oraz po ich zużyciu.



Z zastrzeżeniem prawa do zmian technicznych i błędów drukarskich 12/2015



PORTABLE AIR CONDITIONER

Mini Spot Cooler Mod. FSC 09/12/14

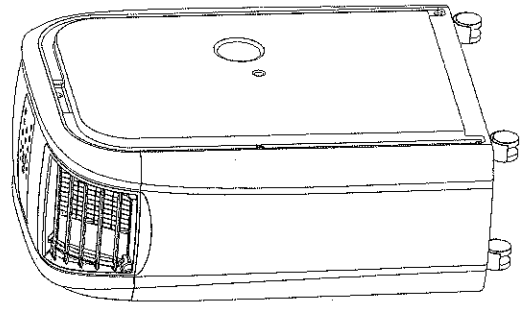

USER'S MANUAL

IMPORTANT: ALWAYS REFER TO THIS MANUAL. ALWAYS CONNECT THE UNIT TO EARTHED SOCKET. PAY ATTENTION WITH CHILDREN. SAVE THIS MANUAL

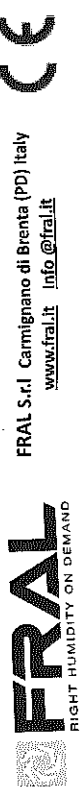

FRAL S.r.l. Carmignano di Brenta (PD) Italy
www.fral.it info@fral.it

BEFORE INITIATION

1. To avoid damage, place the unit in an upright position for at least 24 hours before initiation.
2. Release the holder air hose in the unit and take out the extract air hose.
3. Fasten the air hose before initiating the unit.
4. Turn the extract air hose in the direction of the arrow 1 displayed and remove it from the unit.
5. Turn the extract air hose in the direction of the arrow 2 displayed and connect it to the unit.

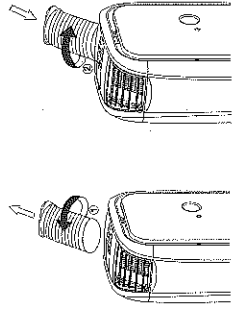

6. Plug the power plug into a socket. Never pull the plug out of the socket with force using the connection line. This can damage the power cable.
7. Since the unit emits hot air, please observe a sufficient minimum safety distance to each wall. (Fig. 1)

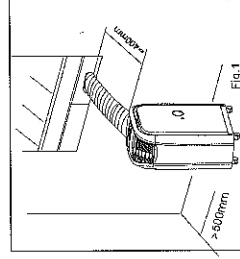

8. Despite the splash water protection, you should not operate the unit in moist areas, such as e.g. swimming baths or similar areas.
9. The colour of the unit can change slightly due to direct solar radiation.
10. The unit is equipped with a special thermal deactivation. This protects the unit from overheating in extreme ambient conditions.
11. Please place the unit so that the air inlet is not impeded, e.g. by furniture or curtains, since this can negatively affect the capacity.
12. Do not expose direct sunlight to shine on the unit, since it may then overheat and automatically deactivate on account of the thermal deactivation.

INTRODUCTION / TECHNICAL DATA

Congratulations on purchasing portable type air conditioner. Your air-conditioner has been developed and manufactured in accordance with standards of state of the art technology.

Please read the operating instructions carefully before connecting your unit to the power supply in order to prevent damage from improper use. Pay special attention to the safety instructions. If you pass this unit on to a third party, you must also include these operating instructions. Please keep these operating instructions in a safe place for any questions which may arise in future.

Thank you for showing confidence in our product. We hope you enjoy a pleasant room climate with your air-conditioner.

MODEL	FSC09	FSC12	FSC14
VOLT	220-240V~50Hz	220-240V~50Hz	220-240V~50Hz
RATED POWER (W)			
COOLING	1100 W	1480 W	1700 W
HEATING	950 W	1300 W	1500 W
(EN60335)			
COOLING CAPACITY	2600 W	3500 W	4000 W
HEATING CAPACITY	2600 W	3500 W	4000 W
(W624 / Db35)			
DEHUMIDIFICATION CAPACITY	50L/day	60L/day	70L/day
(30, RH80%)			
NOISE	65 dB	65 dB	65 dB
AIR CIRCULATION [m³/h]	360	450	450
COOLING AGENT	R410A	R410A	R410A
REMOTE CONTROL	INCLUSIVE	INCLUSIVE	INCLUSIVE
TIME SWITCH	0-24 STD	0-24 STD	0-24 STD
DIMENSIONS (mm) WxDxH	300x526x624	300x550x760	300x550x760
NET WEIGHT	25 kg	29.5 kg	30.5 kg

All figures are approx. data. Characteristics pursuant to current Norm EN 14511. Subject to alterations.

EASY TO OPERATE AND TO EASY TO MOVE AROUND

- ✓ The unit can be moved easily on rollers from room to room.
- ✓ The air quantity can be adjusted via up to three ventilation levels.
- ✓ The air flow can be very strong and reach up to 5 or 6 metres.
- ✓ Installation by a specialist is not required
- ✓ Simply plug into a normal household socket with an operating voltage of 220-240V/ 50Hz.
- ✓ The extract air hose can be stored in the unit for transport and when not in use.
- ✓ This unit operates in accordance with the heat pump principle. On account of the special, innovative construction of the unit, its heating function is extremely efficient compared to conventional heating units.

SCOPE OF DELIVERY

- | | | |
|------------------------|---|----------------------------|
| 1 x unit | 1 x bracket air hose | 1 x operating instructions |
| 1 x remote control | 1 x sir outlet grid | 1 x drainage hose 50 cm |
| 1 x air hose 150 cm | 1 x coarse filter top, 1 coarse filter bottom | 2 x sealing plug |
| 1 x air hose connector | | |

NAME OF THE COMPONENTS

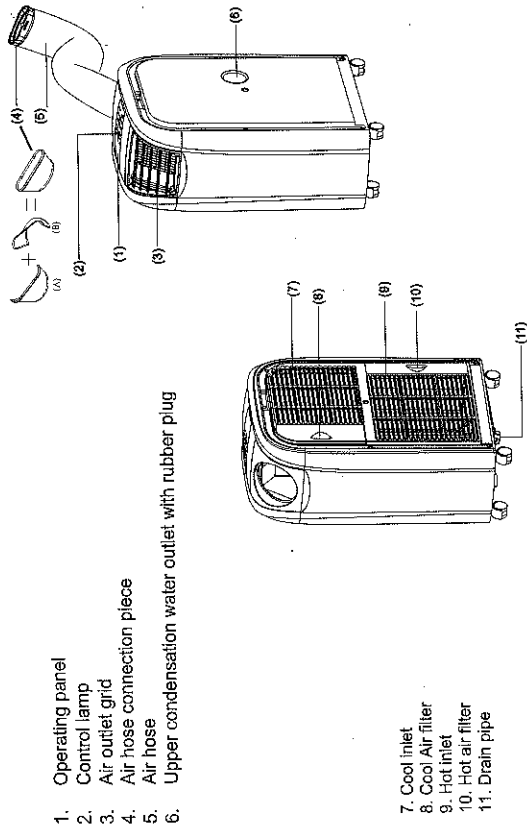

1. Operating panel
2. Control lamp
3. Air outlet grid
4. Air hose connection piece
5. Air hose
6. Upper condensation water outlet with rubber plug

7. Cool inlet
8. Cool Air filter
9. Hot inlet
10. Hot air filter
11. Drain pipe

IMPORTANT INSTRUCTIONS

1. Before initiation, check if the operating voltage specified on the type plate complies with the local network voltage.
2. **DO NOT BLOCK THE VENTILATION.** Make sure that the air outlet and air inlet are never blocked.
3. Only operate the unit on a horizontal surface to ensure no water leaks out.
4. The unit must not be operated in an area with explosive and caustic substances.
5. Clean the air filter regularly. A contaminated air filter reduces capacity.
6. Please wait at least 5 minutes after switching off the unit before switching it back on, to ensure the compressor is not damaged.
7. The compressor of the unit has a power demand of at least 7 amps. Do not use any extension cable with this unit.
8. The unit is designed for the cooling, heating and dehumidification of inside rooms. Other use is excluded.
9. If the power cable is damaged, it must be replaced by a qualified specialist for safety reasons.
10. **CAUTION!** This unit may only be used by persons (including children) with reduced physical, sensorial or mental capacity or with insufficient experience and lack of specialist know-how, if such persons are supervised by a person responsible for their safety or who has been trained in the use of the unit. Children should be supervised to ensure they do not play with the unit.

OPERATING PANEL

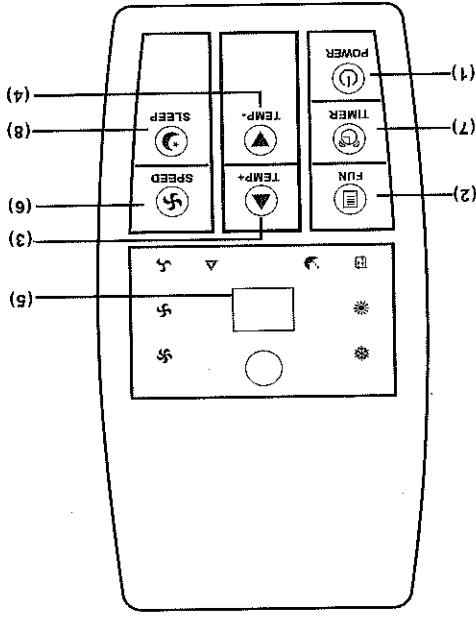

DESCRIPTION OF FUNCTIONS

1. **[POWER]**
Press this switch to switch on or off
 2. **[FUN]**
Press this switch to select between the functions "Cooling", "Heating" or "Dehumidity"
 3. **[TEMP+]**
Press this switch in the cooling function in order to set the required room temperature by 1°C respectively up to a maximum temperature of 30°C.
Press this switch in the heating function in order to set the required room temperature by 1°C respectively up to a maximum temperature of 25°C
 4. **[TEMP-]**
Press this switch in the cooling function in order to set the required room temperature by 1°C respectively up to a minimum temperature of 17°C.
Press this switch in the heating function in order to set the required room temperature by 1°C respectively up to a minimum temperature of 15°C
- To change the reading from Centigrade "°C" to Fahrenheit "°F" degrees and viceversa, press "FUNC" key for 5 seconds.
5. **LED-DISPLAY**
The display shows the setting temperature in operation.
By pressing the **[TEMP+]** or **[TEMP-]** switch, the required target temperature is briefly displayed. On pressing the **[TIMER]** switch, the number of hours is briefly shown until activation or deactivation. After each manual setting, the display automatically shows the setting temperature. In the dehumidification function, "DH" is shown in the display. Error messages are also shown in the display.
 6. **[SPEED]**
Press this switch to set the ventilation speed to "LOW", "MID" (middle), "HI" (high) or "AUTO" (automatic). If "AUTO" is selected, the ventilator operates at temperature differences larger than 9 degrees at top speed. If the temperature reduces to a difference smaller than 4 degrees, the ventilator switches to middle blower position. If the temperature reduces further until the target temperature, the ventilator switches to the lowest blower position.

[TIMER] Programmable time switch with start and residual time expired. Proceed as follows:

- Starting time:** This function is used to switch on the unit automatically when the time entered has expired. Proceed as follows:
- i) Press **[TIMER]** switch in Stand-by (this unit is connected but not in operation), to enter the required number of hours after which the unit is to start.
- ii) Select the required function (cooling, heating, dehumidification) and set the required temperature.
- iii) When the set number of hours has expired, the unit starts automatically.

If you press the **[POWER]** switch before the time has expired, the time programming is deleted. The unit switches on and can be operated in the required operating mode.

Residual time: This function is used to automatically deactivate the unit when the time entered has expired. Proceed as follows:

- i) Press the **[TIMER]** switch during operation and enter the required number of hours after which the unit is to switch off.
- ii) After the flashing of the number of hours on the LED has stopped, you can select the required function (cooling, heating, dehumidification) and the required temperature.
- iii) When the set number of hours has expired, the unit switches on automatically.

If you press the **[POWER]** switch before the time has expired, the Timer programming is deleted and the unit switches off.

8. [SLEEP]

Using this key you can set the sleep function of the unit. The microprocessor integrated in the unit will raise the pre-set temperature by 2°C per hour up to a maximum of 4°C after 2 hours and maintain this temperature until the set time has expired.

If you use the sleep function, first set the time switch to the set hours as described in the functions **Residual time** or **Starting time**. Then press the **[TIMER]** switch until the required hours appear on the display. After the hour display, the display switches automatically to the previous set temperature display. To change the temperature, press the switch **[TEMP+]** or **[TEMP-]**. With each press on the switch, the temperature increases or decreases by 1°C.

COOLING

- ✓ It is recommended to start the unit early on hot days, thus avoiding heating up of the room.
- ✓ This unit has a self-evaporation function for condensation water, so that it is normally not necessary to empty the water tank in cooling mode. The drainage hose need not be connected. Please make sure that the outlet is closed with the rubber cap during operation.

(This does not apply in the case of high air humidity. If the unit operates in cooling mode for a longer period and especially at a time of year with high air humidity, the condensation tank may be full. The control lamp will remind you to empty the water. Refer to error message E4. In such a case, empty the water tank via the condensation water outlet. If continuous high air humidity is likely, it is recommended to drain the condensation continuously via the drainage hose.)

COOLING IN INDOOR OPERATION

The unit stands in the room to be cooled. Connect the air hose and the air outlet grid to the unit as displayed in the illustration; the air hose connection piece and air outlet grid need to be exchanged.

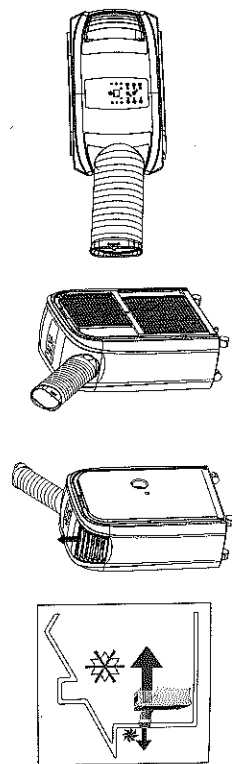

The warm extract air must be emitted from the room via the air hose. This can be executed e.g. via a tilted window, a door or wall aperture. Make sure that no warm outside air can enter the room. For effective cooling, we recommend our selection of various accessories which reduce or prevent entry of warm air into the room.

Place the function to "COOLING". Set the target temperature using the temperature control. The settable temperature range is between 17 and 30 degrees target temperature. The unit must only be used in an ambient temperature of maximum 32°C.

Note: After switching on, or over, the ventilator operates, but the compressor only starts after the control lamp has flashed for three minutes. Cooling effect may require a further 10 minutes. Further information is available under the item, "Troubleshooting".

COOLING IN OUTDOOR OPERATION

The unit is outside the room to be cooled. Connect the air hose and the air outlet grid to the unit as displayed in the illustration; the air hose connection piece and air outlet grid need to be exchanged.

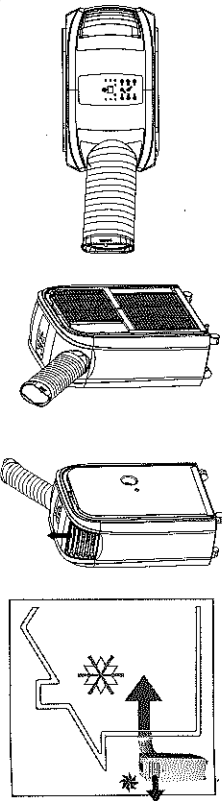

Place the unit in the shade if possible and in a cool place in order to increase efficiency and to avoid overheating. At an ambient temperature of over 32 degrees, the unit may deactivate. If this occurs continuously, we recommend you temporarily use the INDOOR OPERATION of the unit. We recommend that a drainage hose for condensation water be connected.

Set the function to "COOLING". The settable temperature range is between 17 and 30 degrees. This can be set using the temperature control.

The air with high oxygen content cooled by the unit is fed into the room via the air hose. This can be executed e.g. via a tilted window, a door or wall aperture. Make sure that no warm outside air can enter the room. For effective cooling, we recommend our selection of various accessories which reduce or prevent entry of warm air into the room, or via the remote control.

Using the various "Comfort Control Kits" you can also control the unit from inside using the remote control.

After switching on, or over, the ventilator operates, but the compressor only starts after the control lamp has flashed for three minutes. Cooling effect may require a further 10 minutes. Further information is available under the item, "Troubleshooting".

HEATING

- ✓ On cold days it is recommendable to start the unit early in order to avoid intensive cooling of the room.
- ✓ For the heating function and to improve the heating effect and avoid lower temperatures (lower than 17°C) we recommend you remove the rubber plug from the condensation water outlet and allow the condensation water to leak out of the unit using the drainage hose. However, the drainage hose does not have to be connected in the heating mode. Please make sure that the condensation water outlet is closed with the rubber cap during operation. In such a case, proceed analogously to the emptying of the water tank in the cooling function.
- ✓ The heating function of the unit must not be operated at a room temperature of more than 23°C or less than 7°C. The unit can also be operated with heating function, if the outside temperature is lower than 7°C. However, you must then ensure that the unit is operated inside and the room temperature is at least 7°C.

Caution: In the heating mode, separate setting of the ventilator is not provided, since the highest ventilation level is already preset to avoid overheating of the unit.

HEATING IN INDOOR OPERATION

The unit is in the room to be heated. Connect the air hose and the air outlet grid to the unit as displayed in the illustration; the air hose connection piece and air outlet grid need to be exchanged.

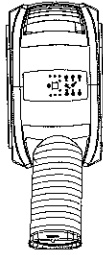
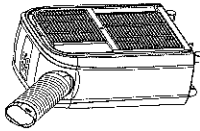
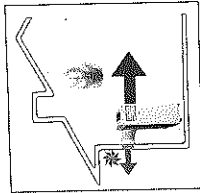

The cold extract air has to be fed out of the room via the air hose. This can be executed e.g. via a tilted window, a door or wall aperture. Make sure that no warm outside air can enter the room. For effective heating, we recommend our selection of various accessories which reduce or prevent entry of cold air into the room.

Set the function to "Heating". The settable temperature range is between 15 and 25 degrees target temperature. You can set this using the temperature control.

After switching on, or over, the ventilator operates, but the compressor only starts after the control lamp has flashed for three minutes. Cooling effect may require a further 10 minutes. Further information is available under the item, "Troubleshooting".

HEATING IN OUTDOOR OPERATION

The unit is outside the room to be heated. Outdoor operation is ideal for the transition period in which outside temperatures do not fall below 7 degrees. (If the outside temperature should however fall below 7 degrees continuously, we recommend indoor operation). Connect the air hose and the air outlet grid to the unit as displayed in the illustration, or the air hose connection piece and air outlet grid need to be exchanged.

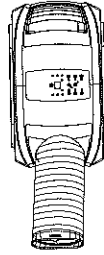
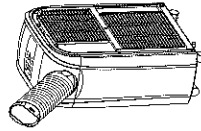
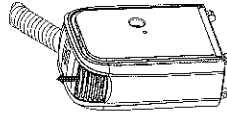
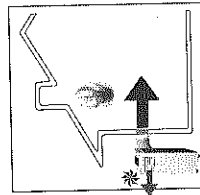

Set the function to "Heating". The settable temperature range is between 15 and 25 degrees target temperature. You can set this using the temperature control.

The air with high oxygen content heated by the unit is fed into the room via the air hose. This can be executed e.g. via a tilted window, a door or wall aperture. Make sure that no warm outside air can enter the room. For effective heating, we recommend our selection of various accessories which reduce or prevent entry of warm air into the room.

Using the various "Comfort Control Kits" you can also control the unit from inside using the remote control.

After switching on, or over, the ventilator operates, but the compressor only starts after the control lamp has flashed for three minutes. Cooling effect may require a further 10 minutes. Further information is available under the item, "Troubleshooting".

DEHUMIDIFICATION

Humidity is extracted from the air, collected in the water tank and discharged via the condensation water outlet. Only air the room if the humidity of the outside air is below that in the inside room. Set the function to "Dehumidify".

Caution: In the dehumidify mode, separate setting of the ventilator is not provided, since the lowest ventilation level is already preset to ensure efficient dehumidification of ambient air.

The rubber plug of the condensation water outlet is removed and a drainage hose attached. To collect the condensation water easily in a tank, a drainage hose is included in the scope of delivery which you can connect to the upper condensation water outlet. Allow water to flow out continuously in order to achieve higher dehumidification capacity. In the dehumidify mode, you must not feed the room air outside with the extract air hose.

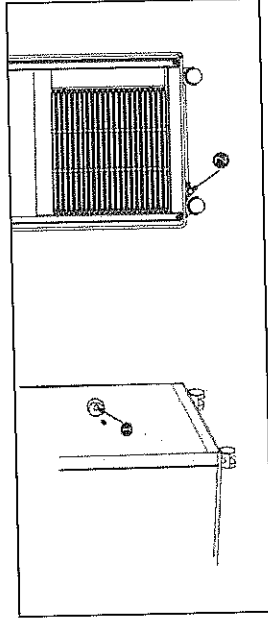

CLEANING AND MAINTENANCE

MAINTENANCE

PLEASE REMOVE THE POWER PLUG FROM THE SOCKET BEFORE CLEANING THE UNIT.

COARSE FILTER

The air filters on the side of the unit can be simply removed by pulling the frame sideways. When cleaning, use a vacuum cleaner with brush or wash the filters under running, warm water and dry them with a soft cloth!

Please clean the coarse filters before initial use, and regularly when in use.

ERROR MESSAGES

The mobile air conditioner is equipped with a 3-minute compressor-delay system which means the compressor needs 3 minutes to start. This affects the switching on of the unit (POWER), as well as switching over from one function to the next, e.g. defumidify to cooling or heating.

ERROR/ PROBLEM	CAUSE	REMEDY
Can I switch the unit on immediately after unpacking it?		No. The unit must be placed upright for at least 24 hours after every transport. Otherwise the compressor may be damaged and there is no capacity.
When switching on the unit I sense a smell. What should I do.	Production-related cause or incorrect storage of unit at e.g. dusty areas.	Odour development can arise on first use and after a longer period of non-use by storing in unsuitable areas (e.g. dusty areas). Run the unit for 1/2 a day. The smell will disappear after a while. In the case of intensive odour development, air the room.
Can I operate the unit WITHOUT the extract air hose.		No. To achieve temperature adjustments, surplus heat or coldness must be discharged.
At which intervals should the activated carbon filter of the unit be replaced?		To use the purpose of the filter fully, it should be replaced every 6 months.
How can I increase the efficiency of the unit?		External circumstances exist which may impact the efficiency of the unit. Room insulation, use of wall/window adapter, ratio of window space (solar radiation), operation of electrical units in the room (EDP), presence of several persons in the room. You can increase the efficiency of the unit accordingly by adjusting such circumstances.
Compressor does not activate		Depending on ambient temperatures and unit type it may take approx. 10 minutes after starting the compressor until the cooling/heating capacity is reached.
unit deactivates.		On reaching the set required temperature, the unit switches off automatically. Check manual setting of the required temperature as well as the TIMER setting.
How is the m ² or m ³ data of the manufacturer calculated		The m ² or m ³ data of the manufacturer for the various units are average values related to a room height of 2.5 metres. It must be considered that such data can be clearly underscored or exceeded under certain circumstances. Circumstances which work against efficiency of the units include e.g. bad insulation of the building, large window areas, south facing, attic apartment, many additional heat sources, such as e.g. number of persons, EDP, light, kitchen units, washing units etc.
unit does not cool correctly		You achieve the most effective and economical cooling comfort if you already cool the room to be cooled when the room temperature is not yet heated up. Air conditioners operate more effectively if the temperature is to be maintained. To drastically cool the air and inventory in a fully heated room requires much more time and energy.
E1	Room temperature outside the function range.	Observe all data in these operating instructions concerning function range.

E2	Room temperature inside the function range:	New measurement of start temperature. Please switch the unit off and start it again after approx. 30 minutes. If the error occurs continuously, the unit requires specialist inspection.
E4	Temperature of the cooling agent lines too high or too low	Temporary error on measuring output temperature. Please switch the unit off and start it again after approx. 30 minutes. If the error occurs continuously, the unit requires specialist inspection.
DF	Water tank full	If the water tank is full, the warning sign "E4" appears in the display. To restart operation of the unit, please remove the plug of the condensation water outlet to allow water to leak out. Please use an appropriate collection tank. When the water has been completely removed, please start the TRANSPORT unit again. The unit can now be used as usual.
	Defrosting mode	This procedure is completely normal and protects the system from icing and failure. The unit starts automatically after approx. 15 minutes again (depending on the function setting). This procedure repeats itself regularly.

SPARE PARTS AND ACCESSORIES SUPPLY (FAST CONVENIENT SUPPLY)

You can obtain spare parts and accessories for your unit from your local dealer.

NOTE CONCERNING PROTECTION OF ENVIRONMENT

This product must not be disposed of via normal household waste after its service life, but must be taken to a collection station for the recycling of electrical and electronic devices. The symbol on the product, the operating instructions or the packaging indicate such disposal procedures. The materials are recyclable in accordance with their respective symbols. By means of re-use, material recycling or any other form of recycling old appliances you are making an important contribution to the protection of our environment. Please ask your local council where your nearest disposal station is located.

